

An Energy Efficient Backup Scheme with Low Inrush Current for Nonvolatile SRAM in Energy Harvesting Sensor Nodes

Hehe Li,^{*} Yongpan Liu,[†] Qinghang Zhao,^{*} Yizi Gu,^{*} Xiao Sheng,^{*} Guangyu Sun,[‡]
Chao Zhang,[‡] Meng-Fan Chang,[§] Rong Luo[†] and Huazhong Yang[†]

Tsinghua National Laboratory for Information Science and Technology,^{*,†}
Dept. of Electronic Engineering, Tsinghua University, Haidian 100084, Beijing

Center for Energy-efficient Computing and Applications, EECS School, Peking University, Haidian 100871, Beijing[‡]

Dept. of Electrical Engineering, National Tsing Hua University, Hsin Chu 30013, Taiwan[§]

{lihh09, zqx14, gyz10, x-cheng12}@mails.tsinghua.edu.cn^{*}, {ypli, luorong, yanghz}@tsinghua.edu.cn[†]

{zhang.chao, gsun}@pku.edu.cn[‡], mfchang@ee.nthu.edu.tw[§]

Abstract—In modern energy harvesting sensor nodes, non-volatile SRAM (nvSRAM) has been widely investigated as a promising on-chip memory architecture because of its zero standby power, resilience to power failures, and fast read/write operations. However, conventional approaches transfer all data from SRAM into NVM during the backup process. Thus, large on-chip energy storage capacitors are normally required. In addition, high peak inrush current is generated instantaneously, which has a negative impact on energy efficiency and circuit reliability.

To mitigate these problems, we propose a novel holistic backup flow, which consists of a partial backup process and a run-time pre-writeback scheme for nvSRAM based caches. A statistics based dead-block predictor is employed to achieve a fast and low power partial backup process. We also present an adaptive pre-writeback point allocation strategy to further reduce the backup load. Simulation results show that, with our proposed backup scheme, energy storage capacitance is reduced by 34% and inrush current is reduced by 54% on average compared to the conventional full backup scheme.

I. INTRODUCTION

Energy harvesting sensor nodes have been widely used in habitat monitoring, volcano monitoring and structural monitoring due to its ultra-long operating time without maintenance [1]. However, ambient power inputs suffer from the frequent failures due to unpredicted external factors. For instance, ambient RF power varies according to power sources, frequency, distance, height and obstacles [2]. Although independent sensing may be done on those devices under frequent interrupted supply, it may not work for more complicated history-dependent operations. In such cases, it is a must to ensure continuous operations on those battery-less systems with some state-keeping techniques.

In order to maintain state in intermittent power modes, emerging nonvolatile memory (NVM) has been proposed to replace volatile memories in sensor nodes, such as registers, register files and SRAMs. Typical approaches include spin-transfer torque magnetic RAM [3], [4], resistive memory [5] and etc. However, the direct replacement method suffers from the drawbacks of nonvolatile memory, such as high write

energy, slow write speed, asymmetric read/write operations and low endurance. Nonvolatile SRAM (nvSRAM) integrates a SRAM cell and a nonvolatile element in cell levels, forming a direct bit-to-bit connection in a 2D or vertical arrangement to achieve the fast parallel data transfer and fast power-on/off speed [6]. Therefore, it provides comparable power and performance metrics as SRAM, while keeping the nonvolatile capability when power failures happen.

However, backing up full data parallel into nvSARM faces unnecessary large backup energy consumptions and big inrush currents, which may cause significant energy and reliability issues. As a result, prior researches have proposed solutions to mitigate above problems. Sequential backup reduces the inrush current by prolonging the backup time [7], but the backup energy is not reduced and the time is magnitudes longer than the parallel approach. Compression techniques [8], [9] help reducing data to be copied and backup energy consumption. However, compression leads to extra computing energy. What's more, all of above methods adopt an over pessimistic *full backup* scheme, which assumes that full data should be stored.

Recently, several *partial backup* techniques have been raised to avoid unnecessary backup operations. Circuits are proposed to eliminate redundancy in bit levels [10] of nvSRAM. The backup is executed only if there is a difference between the value in the SRAM cell and the one in the nonvolatile element. However, architecture-level redundancy is not fully considered. In fact, there are plenty of architecture-level works to predict dead blocks for cache prefetching and bypassing, such as PC-based [11], [12], counting-based [13] and time-based [14] predictions. Intuitively, these methods can be modified to identify dead blocks and eliminate unnecessary backup. However, as the motivation examples in Section II show, they introduce unacceptable hardware and energy overhead, which is not suitable for embedded applications, such as energy harvesting sensors. In addition, as these methods largely depend on the history trace, run-time computation introduces even more energy overhead. Taking all into considerations, an energy efficient dead block prediction is needed for energy

This work was supported in part by High-Tech Research and Development (863) Program under contract 2013AA013201, NSFC under grant 61202072, joint THU-NTHU project, Huawei Shannon Lab, the Importation and Development of High-Caliber Talents Project of Beijing Municipal Institutions under contract YETP0102.

harvesting scenarios.

This paper proposes a systematic backup strategy for nvSRAM based caches. It consists of two techniques: statistics based dead-block prediction (SBDP) and run-time pre-writeback. Based on the statistics of recent used bits (RUB), SBDP can significantly reduce the backup energy with trivial hardware overhead, which makes it suitable for nvSRAM backup in embedded applications. Besides, a run-time pre-writeback scheme is proposed to reduce the occurrences of rollback caused by excessive dirty blocks. They can separately reduce time and energy penalty in nvSRAM backup operations during the backup and run-time stage, respectively. The fundamental challenges lie in identifying dead blocks accurately and efficiently based on a simple hardware and designing proper pre-writeback strategy. Our specific contributions are listed as follows:

- We propose a systematic backup strategy for nvSRAM based caches, which reduces energy and performance penalties in both the backup and executing stage.
- We present an energy-efficient statistics based dead blocks prediction (SBDP) method, which figures out dead blocks with trivial hardware overhead and its accuracy is comparable to state-of-art techniques.
- We design an adaptive writeback scheme (AWS) to accomplish the pre-writeback process. The scheme has negligible performance and energy overhead but reduces the backup energy significantly.
- Experimental results show that SBDP can achieve over 20% backup energy savings and reduce over 96% time penalty compared with state-of-art dead blocks prediction techniques. The combined SBDP+AWS approach can further reduce the backup energy by 30% and time penalty by 97%.

The rest of the paper is organized as follows. Section II discusses the motivation of the proposed strategy. Section III formulates the systematic backup strategy for nvSRAM. SBDP and AWS are illustrated in Section IV and V. Section VI shows the experimental results and we conclude the paper in Section VII.

II. MOTIVATION

This section first describes the typical architecture of an energy harvesting sensor. After that, the limitations of nvSRAM backup are given out. Fig. 1 shows a typical energy harvesting

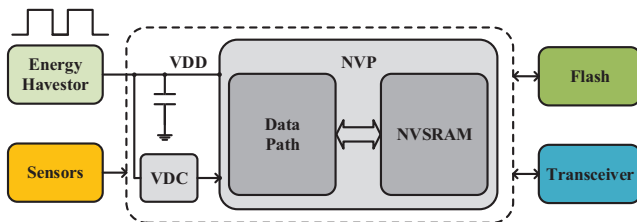

Fig. 1. Energy harvesting nonvolatile sensor node architecture

nonvolatile sensor node. It consists of an energy harvesting module, a nonvolatile processor (NVP), peripheral sensors,

data storage and wireless transceivers. Supposing a square waveform is generated by a vibration based energy harvester, the voltage detection circuit (VDC) detects a power drop when a power failure arrives. The VDC generates a backup signal to the NVP, which starts the backup operation in nvSRAM. Since the backup operations are powered by the energy in the capacitor C_{bp} , its capacity should be large enough to complete the data backup.

Although conventional full backup policy can be reasonable for nonvolatile register files, it brings nontrivial chip area overheads for nvSRAM. For instance, a 32KB nvSRAM based cache, which is common in ARM-cortex A8 processors [15], requires a **107.1nF** on-chip capacitor to supply the backup energy. It leads to over **4.8X** larger chip area compared to the original one if a fully-integrated solution is required. Moreover, it needs hundreds of milliseconds to be fully charged under typical energy harvesting currents, which can even make the system unworkable. Last but not the least, it causes a large inrush current up to several amperes, which has a negative impact on the reliability and limits the maximum nvSRAM capacity.

To solve those challenges, a partial backup method is needed to discard useless data during the backup operation. Dead block prediction (DBP) techniques can be used to detect the useless data, but traditional approaches may not work well in the energy harvesting scenario. Table I summarizes the performance of various state-of-art DBP strategies, including the simplest LRU algorithm and more complicated but accurate DBP techniques.

TABLE I
ACCURACY, FALSE-ALARM RATE, AND HARDWARE OVERHEAD
COMPARISON

DBP	Accuracy	False alarm	Predictor structures	Cache metadata	Total
LRU	66%	17%	-	-	-
Refractre [11]	88%	4%	8KB	1KB	9KB
Cache Burst [14]	96%	4%	4KB	0.7KB	4.7KB

Table I compares prediction accuracy, false-alarm rate¹ and hardware overheads in an 8KB nvSRAM, which is a typical configuration in a nonvolatile sensor node[16]. As we can see, LRU method provides relatively low accuracy and high false-alarm rate, which may cause significant backup energy and performance penalty. However, other complicated DBP methods, which are dedicated to high performance applications, introduce unacceptable hardware overheads in an embedded system. They are even comparable to the nvSRAM size. What's more, state-of-art DBP techniques need history records in the predictor tables, which requires even more nvSRAM and increases the backup energy. Therefore, a lightweight but accurate DBP method is badly needed for energy harvesting sensors.

III. PROBLEM FORMULATION

This section gives out the models and formulates the optimization problem. After that, the two-step flow is presented.

¹A false-alarm error occurs when a cache block is predicted to be dead but referred later. It leads to an extra time penalty as a cache miss happens.

A. Formulation

In a full backup process, the energy consumption of a N -block nvSRAM based cache is $E_{fb} = NE_b$, where E_b is the backup energy per block. The energy consumption in a partial backup E_{pb} can be expressed as follows:

$$E_{pb} = \underbrace{E_{dbp}}_{\text{prediction}} + \underbrace{E_b N_b}_{\text{backup}} \quad (1)$$

where E_{dbp} is the energy consumption of the dead block prediction and N_b is the number of blocks to be backed up.

There are three kinds of sources to cause performance penalties in a partial backup process. 1) Backup failure penalties occur when the capacitor energy can not supply the nvSRAM to backup all dirty blocks. Assuming it happens at a probability of P_{fail} , the system should roll back to its previous backup point due to the data inconsistency. We denote the rollback penalty as $T_{rollback}$. 2) Force-discard penalties happen when all dirty blocks can be backed up, but the live blocks can not. Assuming N_{force} is the number of discarded live blocks, it will lead to a cache miss T_{miss} when the discarded block is accessed. 3) Mis-prediction penalties are caused by wrong predictions from DBP. A penalty will happen only when a live block is predicted to be dead. Therefore, a scale factor α (typically 0.2-0.5) is used to represent such case among all miss-predictions. In general, the total time penalty is expressed as follows:

$$T_{penalty} = \underbrace{P_{fail} T_{rollback}}_{\text{Backup-failure penalty}} + \underbrace{(1 - P_{fail}) N_{force} T_{miss}}_{\text{Force-discard penalty}} + \underbrace{(1 - P_{fail}) \alpha (1 - Accuracy) T_{miss}}_{\text{Mis-prediction penalty}} \quad (2)$$

This paper tries to minimize $T_{penalty}$ under the constraint of E_{budget} , which can be shown as follows:

$$obj : \min T_{penalty} \quad s.t. \quad E_{pb} < E_{budget} \quad (3)$$

B. Proposed partial backup flow

We propose a systematic backup flow for the optimization problem in Fig. 2, which consists of a SDBP technique on the right side and an AWS on the left side. The former aims to reduce both mis-prediction and force-discard penalties. The latter reduces backup failure penalties and relaxes force-discard penalties.

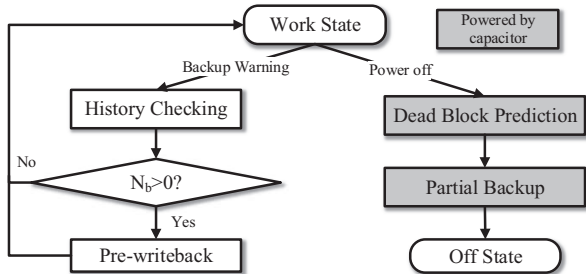

Fig. 2. Proposed partial backup flow, N_b is the required pre-writeback block numbers.

IV. STATISTICS BASED DEAD-BLOCK PREDICTOR DESIGN

This section presents the lightweight but accurate SBDP for the partial backup process. We first discuss the observations and figure out the theory basis. After that, a circuit is implemented to support the SBDP.

A. Theory basis

The theory basis of the SBDP lies in the correlations between the distribution of recently used bits (RUB) and the classification of dead/live blocks. RUB is used in LRU cache replacement algorithm. It represents the order of access time for cache blocks in the same cache set. Fig. 3 shows the

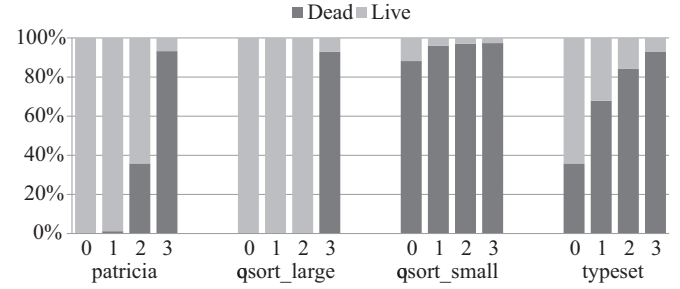

Fig. 3. Block ratio for different RUBs

block ratio under different RUBs when four benchmarks from Mibench [17] are running on a four-way associated cache. Fig. 3 shows that the distribution of block type is different under various RUBs. In Patricia, all cache blocks of RUB=0 and RUB=1 are live. More than half of blocks are live when RUB=2, while mosts of blocks are dead when RUB=3. Specifically, the ratio of dead/live blocks increases/decreases when the RUB becomes larger. This observation enable us to predict block type (dead/live) based on the RUB information. As we can see, different benchmarks show various distributions. Therefore, a dynamic statistical approach should be used.

B. Quantitative analysis

We present a quantitative analysis on the selection of RUB threshold and miss-predictions. First of all, we give the definitions of terms in Table. II. According to the definitions of

Term	Description
N	Number of cache blocks
N_d/N_l	Number of predicted dead/live blocks
N_m	Number of miss-predictions
M	Degree of association
D_j/L_j	Dead/live block ratio for each RUB = j
TH	Death threshold

terms, the number of predicted dead/live blocks can be express as follows:

$$N_d = \sum_{j=TH}^{M-1} D_j \frac{N}{M} \quad (4)$$

$$N_l = \sum_{j=0}^{TH-1} L_j \frac{N}{M} \quad (5)$$

The overall miss-predicted number N_m is as follows:

$$N_m = \left(\sum_{j=0}^{TH-1} D_j + \sum_{j=TH}^{M-1} L_j \right) \frac{N}{M} \quad (6)$$

It can be minimized by choosing an optimal TH . That is

$$TH_{opt} = \underset{TH}{\operatorname{argmin}} N_m \quad (7)$$

Fig. 4 presents the distribution of dead/live blocks. Given

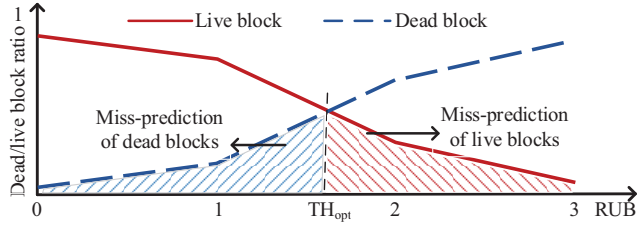

Fig. 4. Diagram of dead/live ratios and the optimal decision threshold derivation

a death threshold TH , the area under the curve represents the number of miss-predictions N_m . Intuitively, the optimal death threshold can be obtained when $TH_{opt} = \{TH | D_{TH} = L_{TH}\}$. If there are multiple points satisfying the condition, we choose the minimum integer TH as the death threshold. Note that $D_j + L_j = 1$, $j = 1, 2, \dots, M$, we have

$$TH_{opt} = TH | D_{TH} = 0.5 \quad (8)$$

Obviously, the death threshold TH needs dynamic adjustments according to different distributions under various benchmarks.

C. Circuit implementation

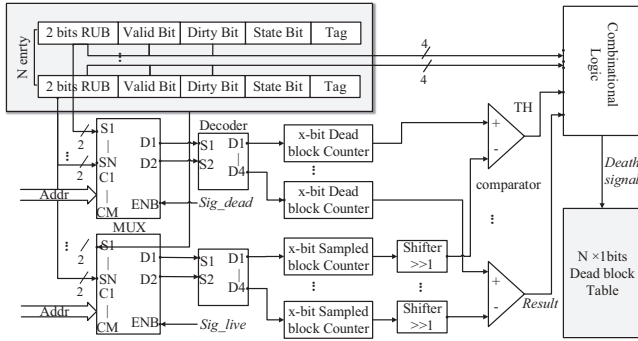

Fig. 5. Circuit of the statistics based predictor

In order to make the SBDP to efficiently track the optimal death threshold TH_{opt} , we implement a circuit in Fig. 5, which shows a SBDP circuit for a 4-way associated cache with N blocks. In this instance, 2-bit RUB fields are used for the 4-way associated cache. Two counter array are used to monitor the number of dead and total sample blocks. After restoration, the state bits for all cache blocks are set to zero. If a dead block with $RUB=i$ is detected and the state bit is zero, both the corresponding dead block counter i and the sampled block counter i are increased by 1. Otherwise, only the sampled block counter is increased by 1. The state bit is set to 1 after the corresponding block's state (dead/live) is confirmed. After some times, assuming the dead-block counter= N and the sampled block counter= M for $RUB=i$, we have the optimal death threshold for RUB when $N/M = 0.5$. The four comparators' outputs represent the death threshold(TH). In

order to avoid complex dividers in hardware, we adopt right shifters and comparators to realize the threshold choosing. Since dirty(invalid) blocks should(not) be always backed up, we use a dedicated logic as follows:

$$Dead\ bit = \overline{VB} \|(Result \& \overline{DB}) \quad (9)$$

, where VB represents to the valid bit, DB is the dirty bit. Final results of dead block prediction are written into the $N \times 1$ bits dead block table, whose entries represent the prediction results for all blocks.

V. ADAPTIVE PRE-WRITEBACK SCHEME

As Equation 2 shown, the total time penalty is also associated the backup failure and the force discard. We propose a pre-writeback scheme to mitigate those penalties.

A. Theory basis

Fig 6 shows an example of a backup failure and a pre-writeback. If the total number of dirty blocks exceeds the maximum backup size, a backup failure occurs. In the run-

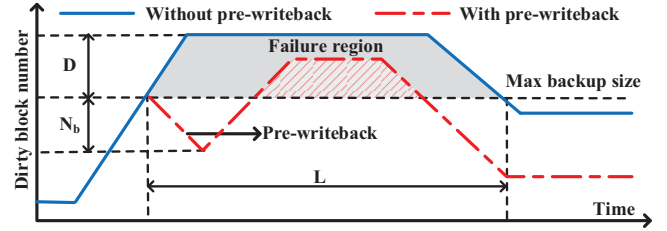

Fig. 6. Backup failure and pre-writeback mechanism

time pre-writeback scheme, a backup warning threshold is set to limit the maximum number of dirty blocks. When its number exceeds the threshold, a pre-writeback is triggered. A number of dirty blocks with large RUBs are written back to the nonvolatile parts. The overall number of dirty blocks is reduced and the force-discard penalties are also relieved because the number of live blocks becomes smaller. However, pre-writeback may lead to nontrivial energy and performance overhead if they are executed frequently. We should adjust the number of pre-writeback blocks N_b dynamically.

Assuming the probability of backup failure is P_0 , the overall probability of backup failure is as follows, when there are N_i times of power intervals:

$$P_F = 1 - (1 - P_0)^{N_i} \quad (10)$$

If N_b dirty blocks are written back, the probability P'_0 becomes:

$$P'_0 = \frac{D - N_b}{D} P_0 \quad (11)$$

,where D is the number of dirty blocks above the maximum data size in Fig. 6. The extra writeback time is $T_{ex} = \gamma N_b T_w$, where $0 < \gamma < 1$ is a scale factor. T_w is the writeback time of a cache block. The overall time penalty is expressed as follows.

$$T_{pen} = \underbrace{\left(1 - \left(1 - \frac{(D - N_b)P_0}{D}\right)^{N_i}\right)}_{\text{failure penalty}} T_{rb} + \underbrace{\gamma N_b T_w}_{\text{extra-writebacks}} \quad (12)$$

Equation 12 includes two kinds of penalties: backup failure and writeback penalties. If N_i increases, the backup failure penalty decreases while writeback increases. T_{rb} denotes the rollback time penalty, which is the accumulated time from the last successful backup point. By taking derivation of T_{pen} to N_b , we have

$$N_b = D - \frac{D}{P_0} \left[1 - \sqrt[N_i - 1]{\frac{\gamma T_w D}{N_i P_0 T_{rb}}} \right] \quad (13)$$

Therefore, N_b is positively associated with N_i . If the number of dirty blocks exceeds the maximum backup size and $N_b > 0$, a writeback will happen.

B. Adaptive pre-writeback algorithm

Algorithm 1 Adaptive pre-writeback algorithm

Input: Task sets, power condition, P_0 , T_w , γ
Output: Pre-writeback decision

- 1: Initial average power on-time $T_{on} \leftarrow 0$, average task processing time $T \leftarrow 0$, $N_i \leftarrow 0$
- 2: **if** A task starts **then**
- 3: Counting D and T_{rb} on-line
- 4: **if** The maximum backup size is reached **then**
- 5: Calculating optimal N_b by equation 13.
- 6: **if** $N_b > 0$ **then**
- 7: Executing the pre-writeback process
- 8: **end if**
- 9: **end if**
- 10: **end if**
- 11: **if** A task is finished **then**
- 12: Getting the task processing time $T_{proc-last}$
- 13: $T = \alpha T_{proc-last} + (1 - \alpha)T$, where α is a weight factor
- 14: **end if**
- 15: **if** A passive power down occurs **then**
- 16: Getting the last power-on time $T_{on-last}$
- 17: $T_{on} = \beta T_{on-last} + (1 - \beta)T_{on}$, where β is a weight factor
- 18: $N_i = T/T_{on}$
- 19: Entering into the partial backup state
- 20: **end if**

Algorithm 1 is an adaptive pre-writeback algorithm. It is designed to on-line calculate N_b and make the pre-writeback decisions. Line 2 to line 10 represents the pre-writeback scheme during task processing. When the maximum backup size threshold is reached, a pre-writeback process is triggered if $N_b > 0$. The predicted power-on time and average task processing time is obtained as a weighted sum of the last power-on time, processing time length and the last prediction as shown in line 11 to 14 and line 15 to 20 in algorithm 1. In practice, α and β are selected to be 0.5. This policy is able to track the variation of processing time and average power-on time. They are used to calculate the power-off times N_i , as shown in line 18 of algorithm 1.

VI. EXPERIMENTAL RESULTS

In this section, we provide comprehensive evaluations to demonstrate the efficiency of the proposed backup flow. We first give the experiment setup. Furthermore, we compare the SBDP with other state-of-art techniques. Finally, we show the tradeoff between the backup capacitor and the performance.

A. Experiment setup

We implement the NVP with nvSRAMs in gem5 [18]. It is configured to model a fabricated nonvolatile processor [16]. We replaced the 8KB SRAM with nvSRAM. All important parameters are listed in Table III.

TABLE III
SIMULATION SETUP

Component	Configuration
Processor (nvMCU)	Single core, 25MHz with 2-width issue
On-chip cache (nvSRAM)	I&D size: 8kB&8kB (4-way association)
	Block size: 64B
	R/W latency: 1/1 clock cycle
	Store energy: 1.714nJ/2kb Restore energy: 1.06nJ/2kb [6]
Off-chip memory (Flash)	I&D size: 512kB&2GB, R/W latency: 300 clock cycle

All benchmarks come from Mibench [17]. For each benchmark, we select ten random backup points and use their average values for evaluations. We fast forward 10M instructions at the beginning to warm up caches and execute 30M instructions of a single benchmark.

B. Statistics based dead-block prediction evaluation

Fig. 7 shows the prediction accuracy of SBDP compared with fixed death threshold policies (TH = 2 and TH = 3). As shown by the solid line, the death threshold (TH) of the SBDP varies from 0 to 3 under different benchmarks. It validates that the proposed architecture can dynamically track and update RUB information. Compared with the fixed threshold policy, our proposed adaptive threshold policy always outperforms or equals to the fixed threshold policy. The average accuracy of SBDP is 91% while those in fixed threshold policies are 67% (TH=2) and 82% (TH=3).

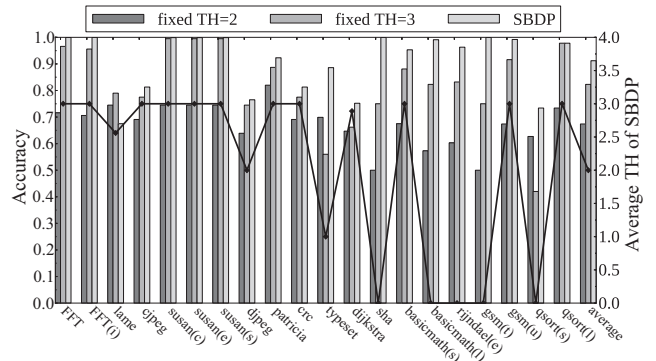

Fig. 7. Prediction accuracy of SBDP compared with fixed TH predictors. The solid line shows the variation of death threshold (TH) of SBDP for different benchmarks.

Table IV compares the SBDP with several state-of-art dead-block prediction methods. Our approach performs comparative prediction accuracy but achieves the best performance. It shows some interesting counterintuitive results. The proposed scheme introduced only 0.25% performance overhead, which outperforms all other strategies with more accurate predictions. This is because those high complicated DBP techniques suffer from very high backup energy, which leads to large performance penalties from force discard and backup failures. They compromise the energy savings from the reduction of the miss-predictions. Moreover, the SBDP consumes much less prediction energy because it only reads 8×32 bits counters along

TABLE IV
COMPARISON OF ACCURACY, STORAGE OVERHEAD AND PERFORMANCE OVERHEAD FOR DIFFERENT DBPs

Prediction strategies	Accuracy	Extra storage	Cache metadata	Total hardware overhead	Backup energy overhead	Miss-prediction penalty	Force-discard penalty	Backup-failure penalty	Total performance penalty
SBDP	91%	48B	16B	64B	0.429nJ	0.15%	0.14%	0	0.29%
SBDP(with pre-writeback)	91%	48B	16B	64B	0.429nJ	0.15%	0.10%	0	0.25%
Refract [11]	88%	8KB	1KB	9KB	63nJ	0.23%	0	50%	50.23%
Cache burst [14]	96%	4KB	0.7KB	4.7KB	33nJ	0.09%	0.22%	7.21%	7.51%

with a 128-bit dead block table. Other prediction strategies need to read a large prediction table and greatly increase the backup overhead. Furthermore, our approach introduces less metadata on caches, while other predictors need to add extra fields such as PC [11] into cache structures. Therefore, the force-discard penalty and backup-failure penalty is reduced. Finally, the SBDP+AWS can provide better performance and less force discard penalties than the pure SBDP approach. It validates the effectiveness of the AWS approach.

C. Capacitor-performance co-optimization

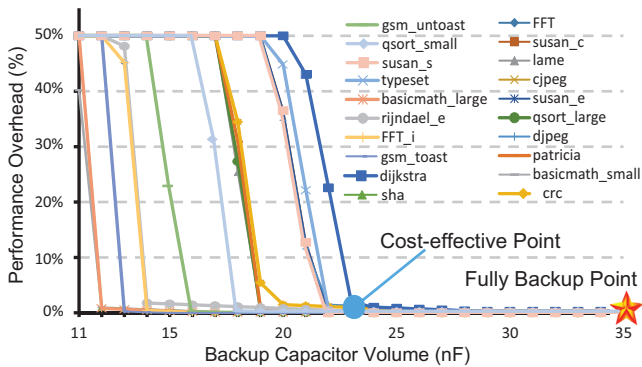

Fig. 8. Performance overhead vs. backup capacitor volume for the benchmark suite. The rollback time is set half of the task processing time, thus the maximum performance loss is 50% when a power failure occurs.

Fig. 8 shows the performance overhead vs. backup capacitor volumes for different benchmarks. It indicates that the performance overhead decreases as the backup capacitor volume increases. The minimum capacitor volume for a full-backup scheme is 35nF. However, our analysis shows that a 23nF backup capacitor, marked as the cost-efficient point, can finish the backup process with only 0.03% performance overhead. In such a case, the total on-chip capacitance can be reduced by 34%. Moreover, the inrush current is decreased by 54% because the total backup load is reduced by discarding dead blocks. It implies that the designers can explore different design space to trade off performance overhead and capacitor volume, which may be a critical factor for tiny sensor nodes.

VII. CONCLUSION

This work proposes an energy efficient, low inrush current backup scheme for nvSRAM based on-chip caches in non-volatile sensor nodes. We reduce the backup burdens through a partial backup strategy along with a pre-writeback scheme. A statistics based dead-block predictor is proposed to identify dead blocks accurately with low power consumption. An adaptive pre-writeback scheme is employed to further reduce the overall performance overhead caused by energy limitation.

Experimental results show that our approach can reduce the backup capacitance by 34% and the inrush current by 54%. The proposed backup strategy can be further used in other nonvolatile architectures such as mobile phones, PCs and servers. In the future, more works will be done to implement the proposed backup scheme. NvSRAM along with the backup scheme will be used more widely to meet the increasing demand of low power devices.

REFERENCES

- [1] S. Sudevalayam and P. Kulkarni, "Energy harvesting sensor nodes: Survey and implications," *Communications Surveys Tutorials, IEEE*, vol. 13, no. 3, pp. 443–461, Third 2011.
- [2] H. Visser, A. Reniers, and J. Theeuwes, "Ambient rf energy scavenging: Gsm and wlan power density measurements," in *Microwave Conference, 2008. EuMC 2008. 38th European*, Oct 2008, pp. 721–724.
- [3] Y. Chen and et al., "Processor caches built using multi-level spin-transfer torque ram cells," in *Low Power Electronics and Design (ISLPED) 2011 International Symposium on*. IEEE, 2011, pp. 73–78.
- [4] Z. Sun and et al., "Multi retention level stt-ram cache designs with a dynamic refresh scheme," in *Proceedings of the 44th Annual IEEE/ACM International Symposium on Microarchitecture*. ACM, 2011, pp. 329–338.
- [5] J. Wang, X. Dong, and Y. Xie, "Point and discard: a hard-error-tolerant architecture for non-volatile last level caches," in *Proceedings of the 49th Annual Design Automation Conference*. ACM, 2012, pp. 253–258.
- [6] P.-F. Chiu and et al., "Low store energy, low vddmin, 8t2r nonvolatile latch and sram with vertical-stacked resistive memory (memristor) devices for low power mobile applications," *Solid-State Circuits, IEEE Journal of*, vol. 47, no. 6, pp. 1483–1496, 2012.
- [7] X. Pan and R. Teodorescu, "Nvsleep: Using non-volatile memory to enable fast sleep/wakeup of idle cores," in *Computer Design (ICCD), 2014 IEEE 32th International Conference on*. IEEE, 2014.
- [8] Y. Wang, Y. Liu, Y. Liu, D. Zhang, S. Li, B. Sai, M.-F. Chiang, and H. Yang, "A compression-based area-efficient recovery architecture for nonvolatile processors," in *Design, Automation Test in Europe Conference Exhibition (DATE), 2012*, March 2012, pp. 1519–1524.
- [9] X. Sheng, Y. Wang, Y. Liu, and H. Yang, "Spac: A segment-based parallel compression for backup acceleration in nonvolatile processors," in *Design, Automation Test in Europe Conference Exhibition (DATE), 2013*, March 2013, pp. 865–868.
- [10] H.-J. Tsai and et al., "Leveraging data lifetime for energy-aware last level non-volatile sram caches using redundant store elimination," in *Proceedings of the The 51st Annual Design Automation Conference on Design Automation Conference*. ACM, 2014, pp. 1–6.
- [11] A.-C. Lai, C. Fide, and B. Falsafi, "Dead-block prediction & dead-block correlating prefetchers," in *Computer Architecture, 2001. Proceedings. 28th Annual International Symposium on*. IEEE, 2001, pp. 144–154.
- [12] J. Ahn, S. Yoo, and K. Choi, "Dasca: Dead write prediction assisted stt-ram cache architecture," in *High Performance Computer Architecture (HPCA), 2014 IEEE 20th International Symposium on*. IEEE, 2014, pp. 25–36.
- [13] M. Kharbutli and D. Solihin, "Counter-based cache replacement and bypassing algorithms," *Computers, IEEE Transactions on*, vol. 57, no. 4, pp. 433–447, April 2008.
- [14] H. Liu and et al., "Cache bursts: A new approach for eliminating dead blocks and increasing cache efficiency," in *Proceedings of the 41st annual IEEE/ACM International Symposium on Microarchitecture*. IEEE Computer Society, 2008, pp. 222–233.
- [15] Cortex-a8 processor. [Online]. Available: <http://www.arm.com/products/processors/cortex-a/cortex-a8.php>
- [16] Y. Wang and et al., "A 3us wake-up time nonvolatile processor based on ferroelectric flip-flops," in *ESSCIRC (ESSCIRC), 2012 Proceedings of the*. IEEE, 2012, pp. 149–152.
- [17] M. R. Guthaus and et al., "Mibench: A free, commercially representative embedded benchmark suite," in *Workload Characterization, 2001. WWC-4. 2001 IEEE International Workshop on*, Dec 2001, pp. 3–14.
- [18] N. Binkert and et al., "The gem5 simulator," *ACM SIGARCH Computer Architecture News*, vol. 39, no. 2, pp. 1–7, 2011.